

AVERETT SEPTIC TANK CO. INC.

1-863-665-1748

2.5" WALL

900 GAL TANK CAT. 3

LEGEND # 53-037-05D

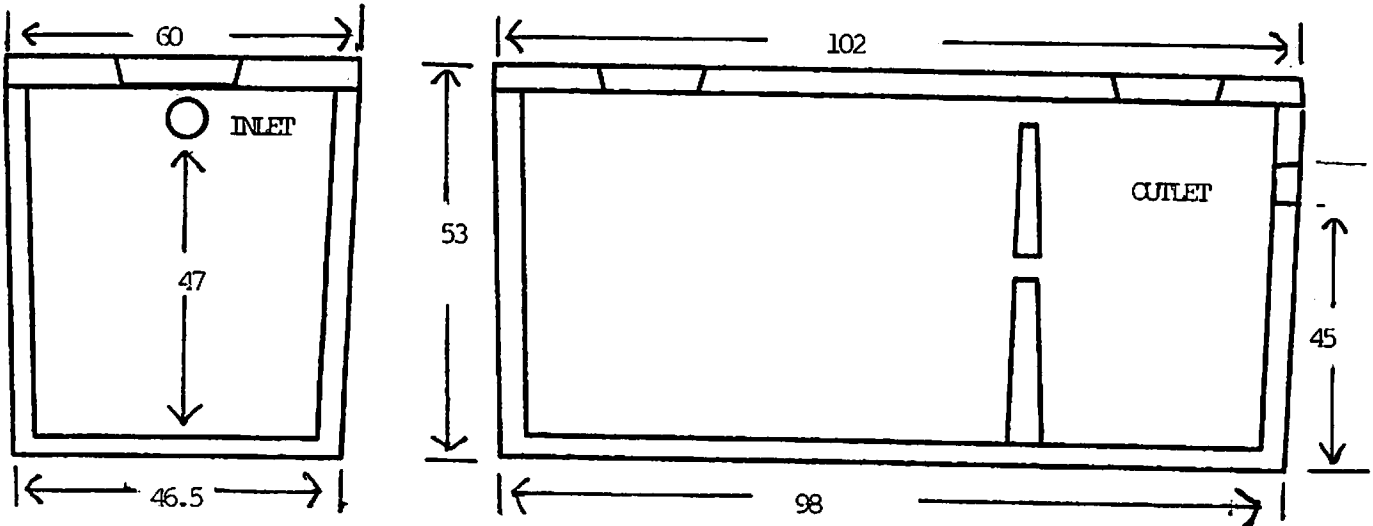

TANK INFORMATION: 900 DUAL COMPARTMENT TANK CAT 3,
CONSTRUCTED WITH FIBER REINFORCED CONCRETE AT A MINIMUM
OF 4000 PSI WITH 2.5" WALLS AND BOTTOM.

LIDS: 3" LID WITH 2-18" SQUARE OPENINGS
8" LID WITH 2-18" SQUARE OPENINGS

WEIGHT: REGULAR TANK & LID = 7,450 LBS
REGULAR TANK & HEAVY DUTY LID = 9,510 LBS

THIS TREATMENT RECEPTACLE IS ENGINEERED AND TESTED BY THE
DEPT. OF HEALTH IN ACCORDANCE WITH CHAPTER 64E-6.013, OF THE
FLORIDA ADMINISTRATIVE CODE (FAC) DATED MARCH 22, 2000.

DRAWING NOT TO SCALE